

DRCOGs

Regional Data Model

A geodata model for COGs/MPOs

Simon Montagu
Director, Customer Resource and Support Division

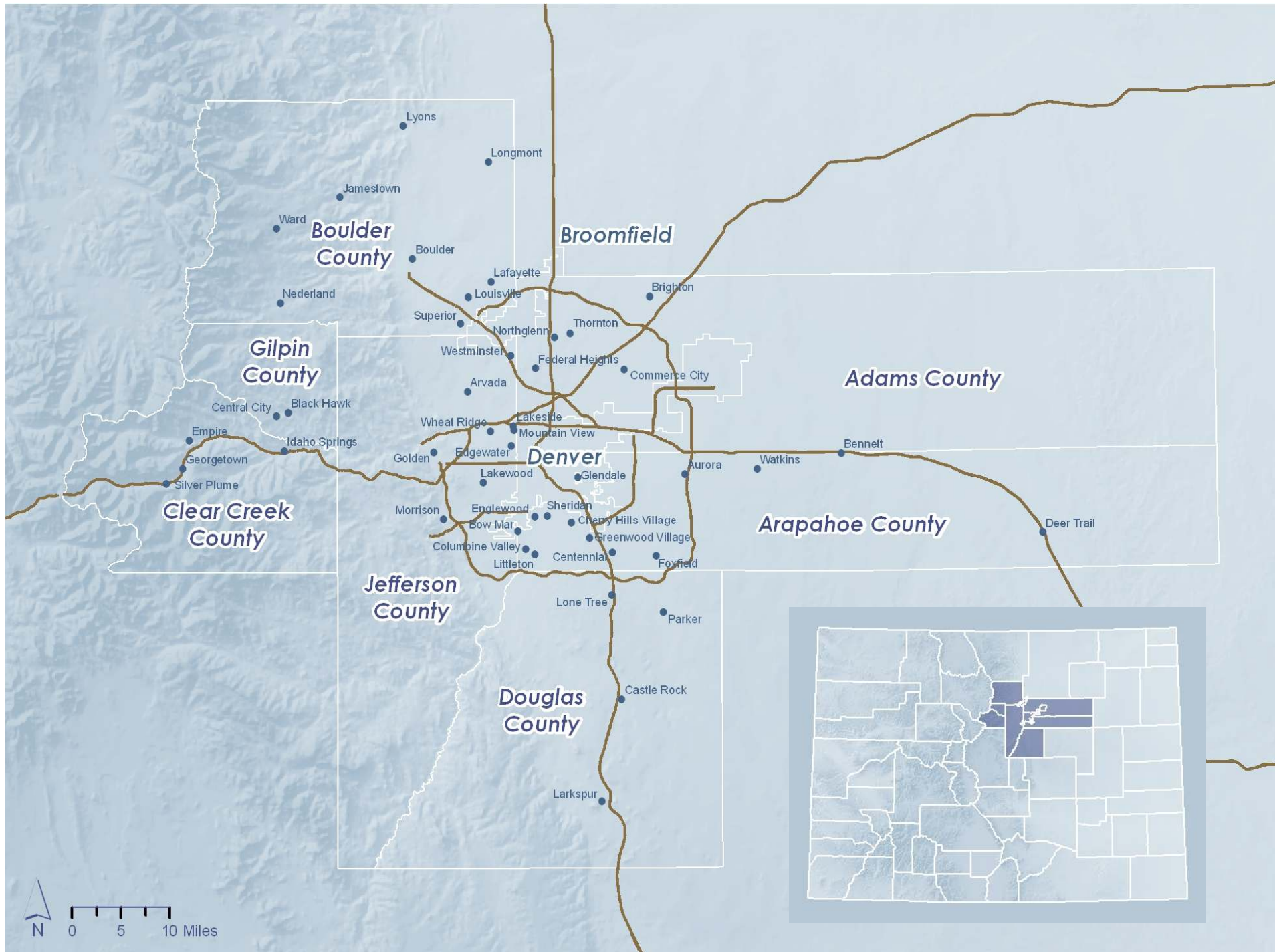







Overview

- Why we need this model
- What we've done so far
 - Conceptual development
 - Ontology
 - Database design and development
 - Data work
 - Behavioral focus – “life stage” work
 - Synthetic population generation
 - Spatial disaggregation
- What we have left to do

Why – big picture

- Philosophical environment
 - Shift to behavioral based socioeconomics
 - Better perspective of reality (?)
- Policy environment
 - More, faster
 - Sketch modeling as well as detailed models
 - More realistic
- Data environment
 - More detailed

Evolution of our RDM: Integrated Regional Model

SAME data across the org
ALL spatial data

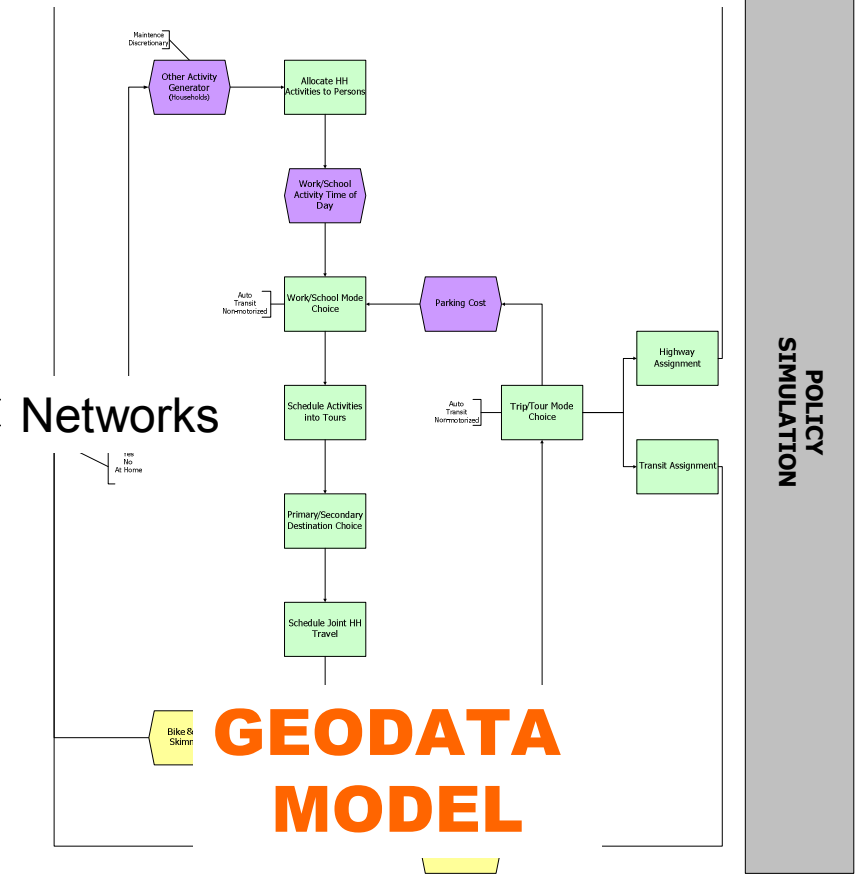
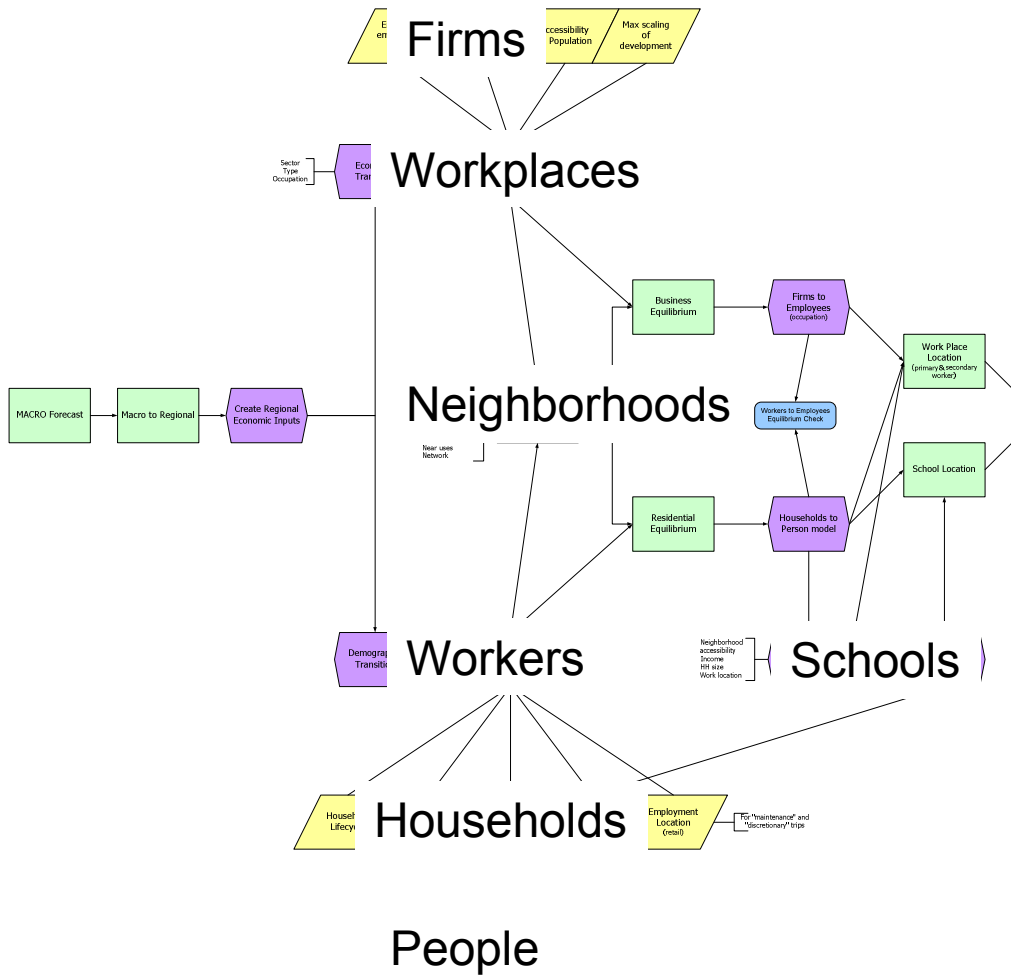

**Status: What we've done
so far**

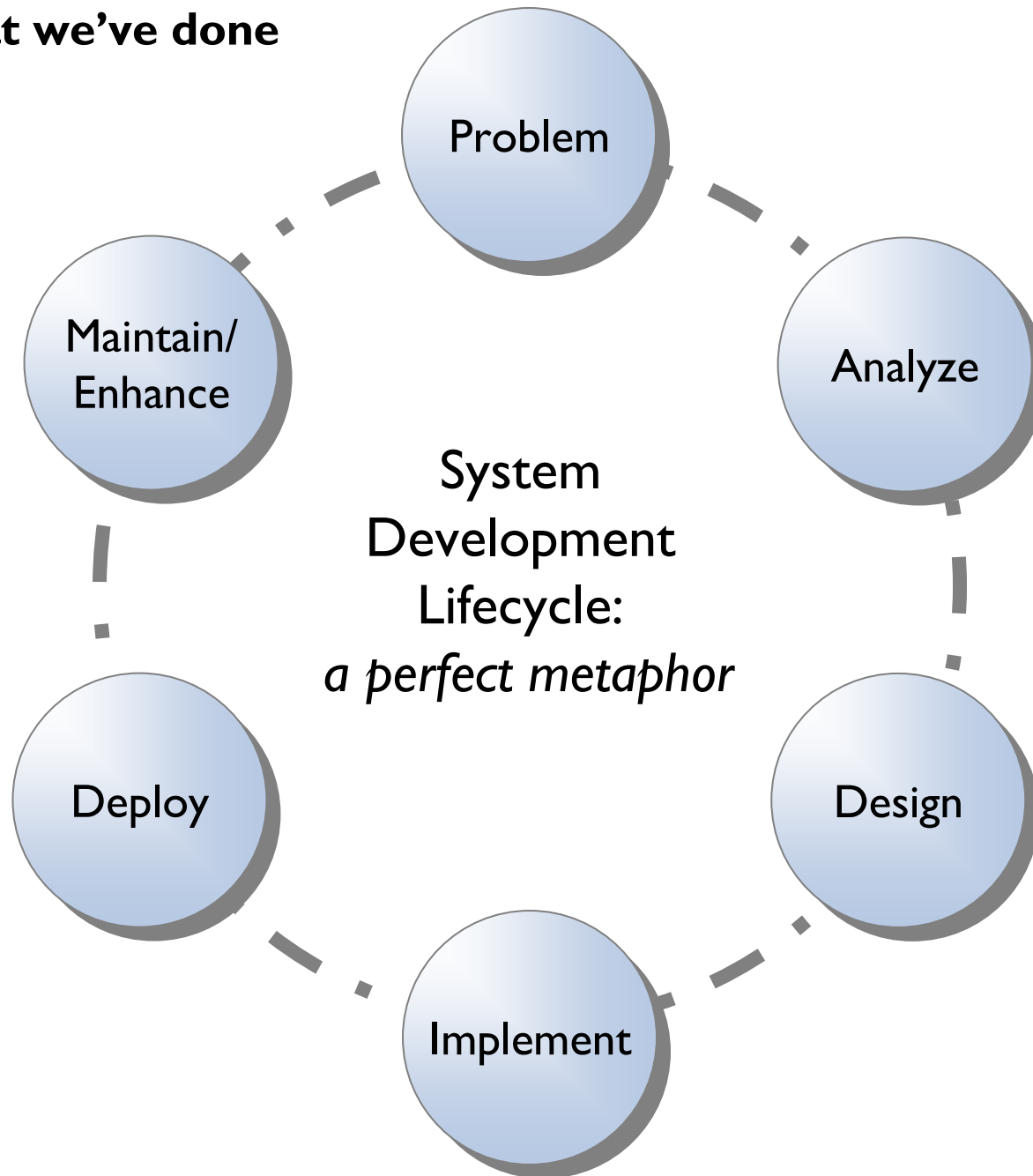

**Data rich,
Information poor**

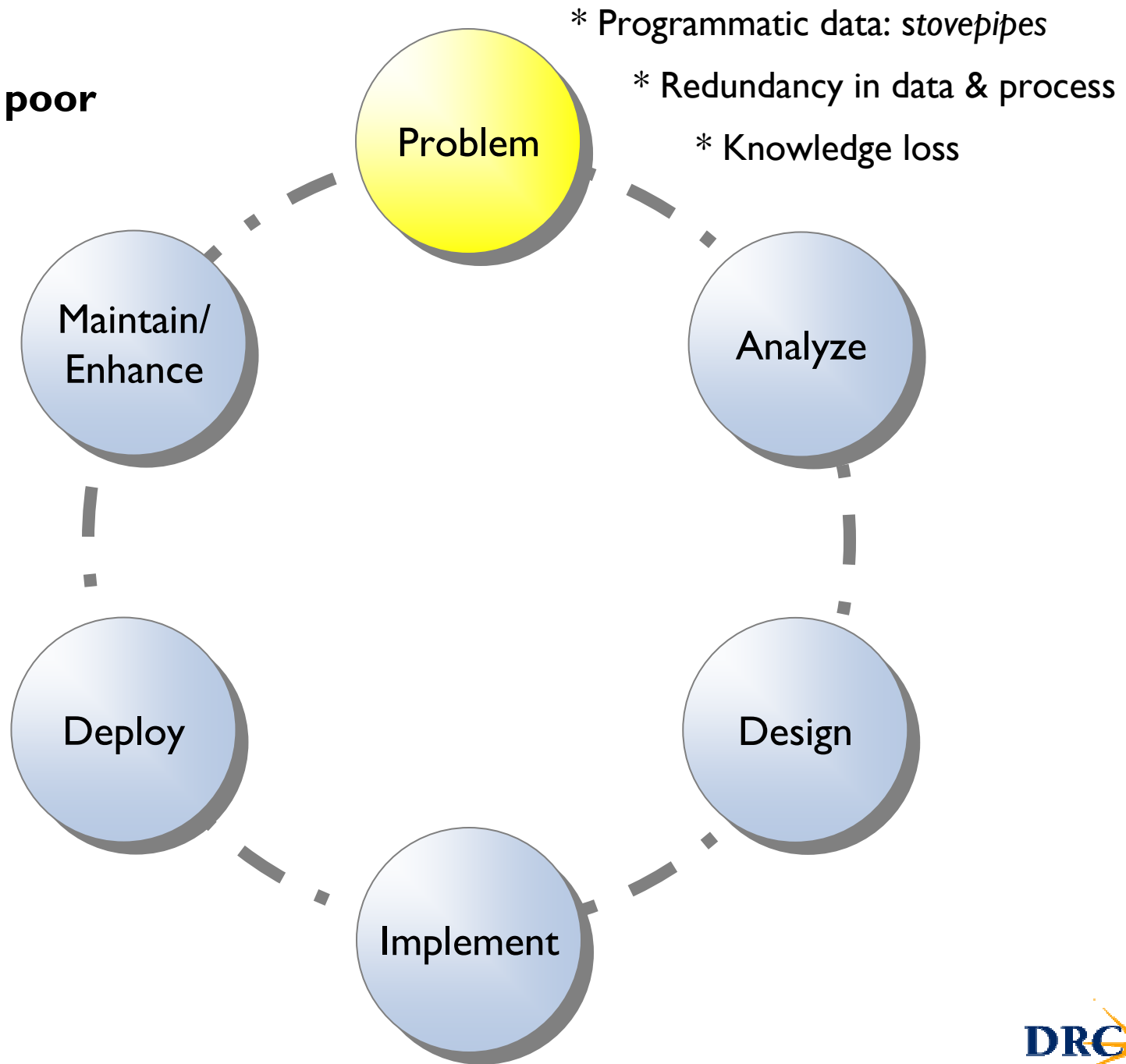

Brainstorming

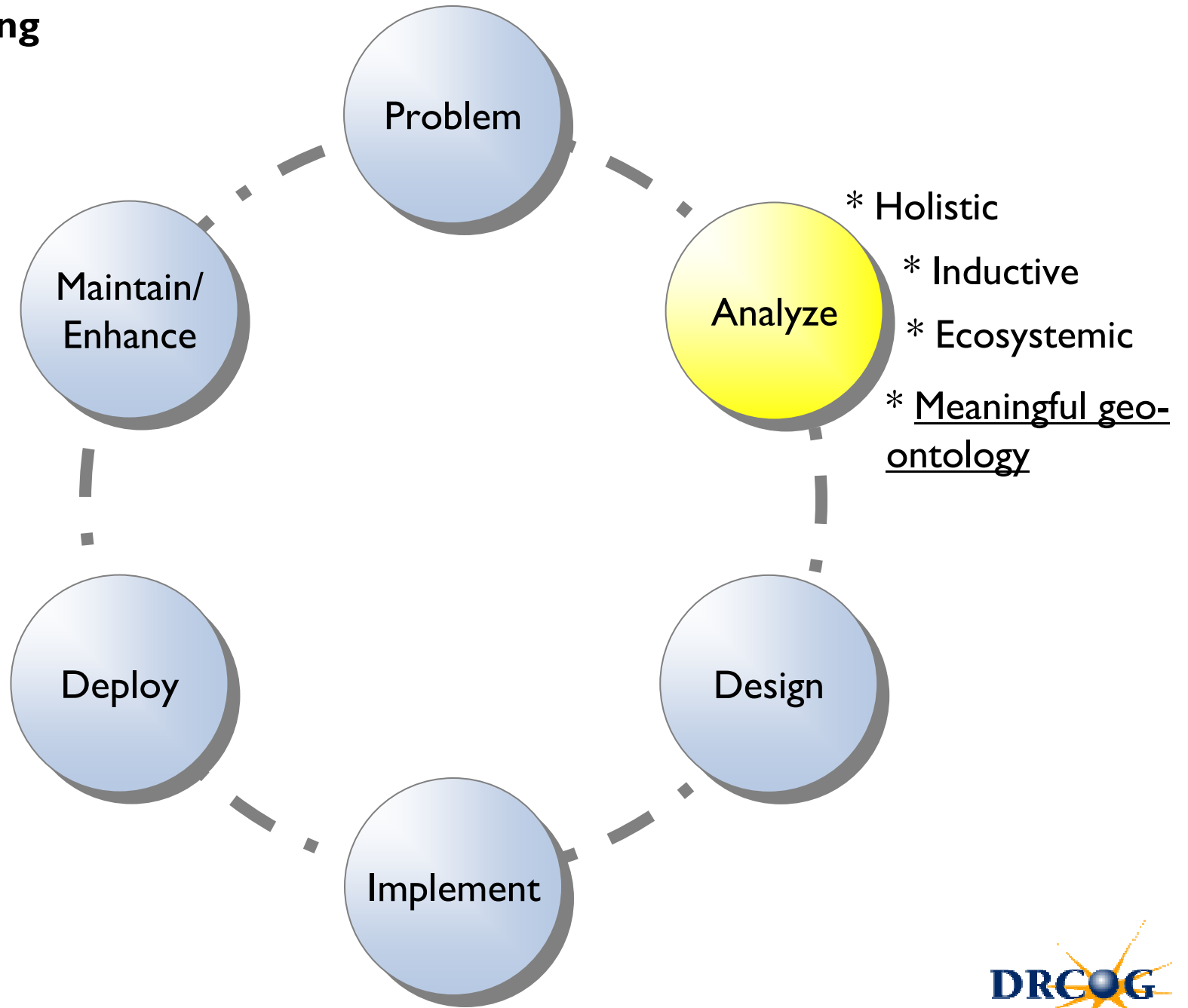



Design principles

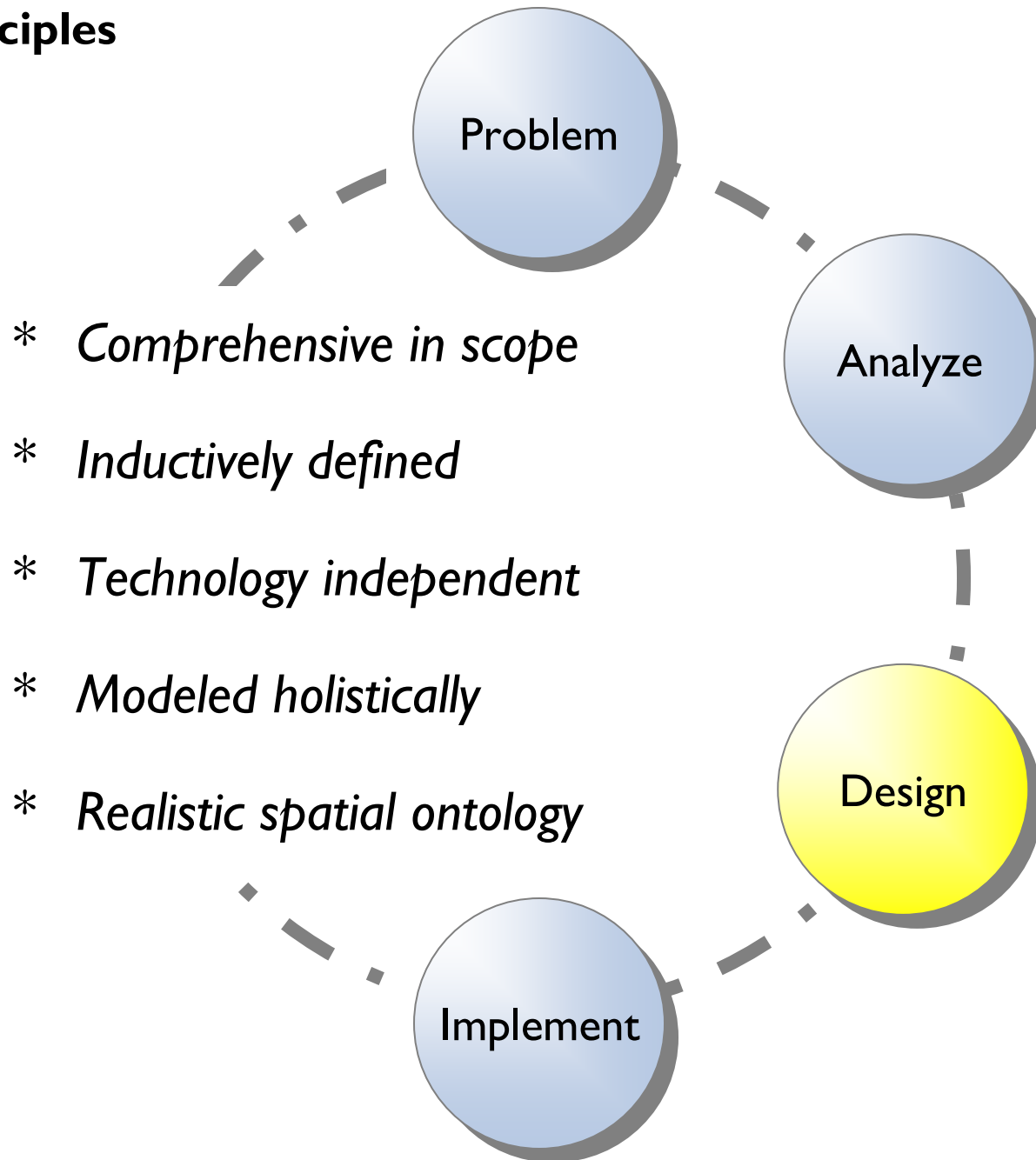

An object way of thinking

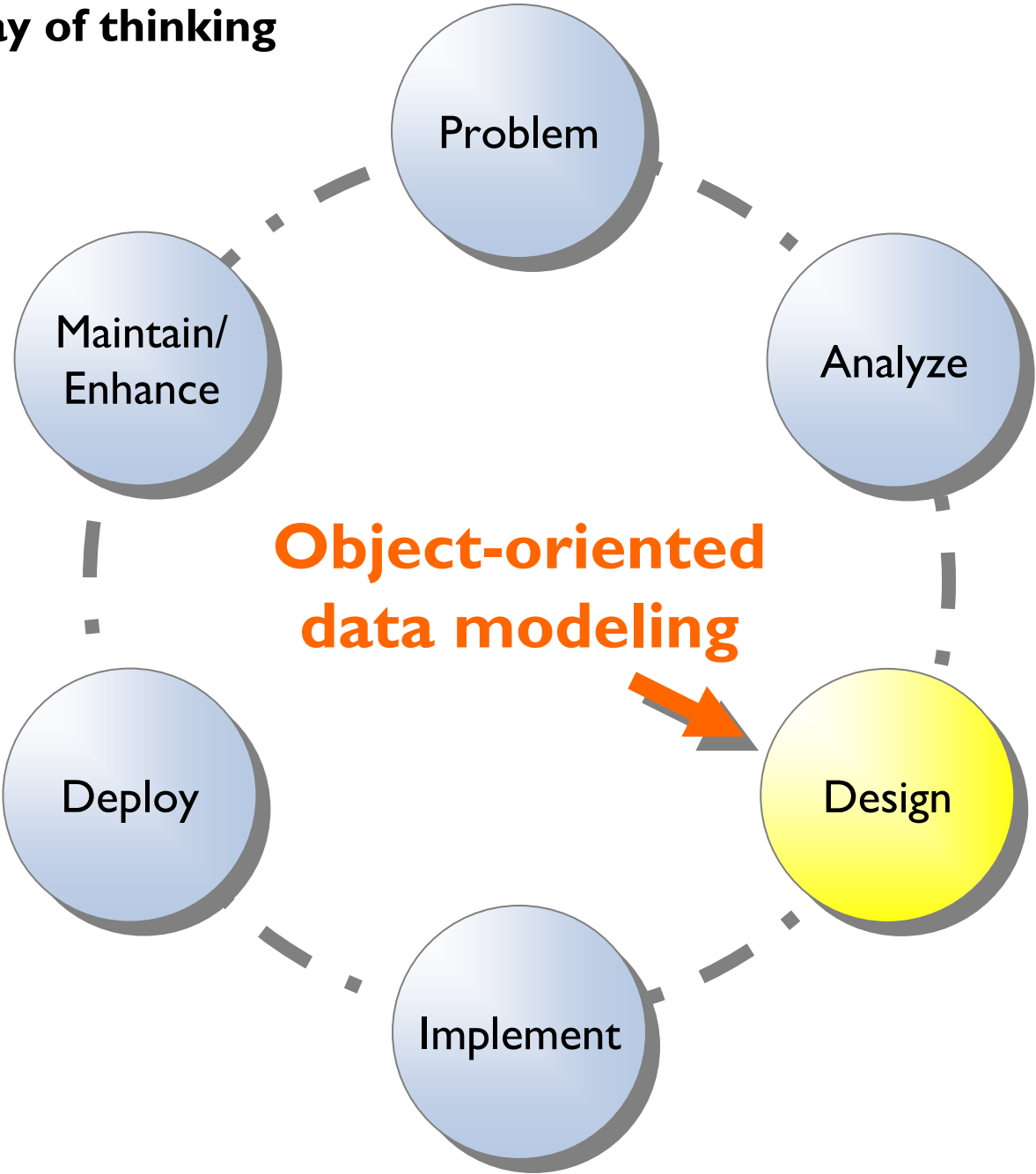

OODM

- Distinct “object-oriented” way of thinking
 - Nouns rather than verbs
 - Identified through bottom-up, inductive process
- World populated by objects – “ecosystemic” in its thinking
 - Unique, independent and autonomous agents
 - Do nothing but be themselves!

OODM

- Paradigmatically different from existing ontologies of space
- Object is primary
 - Object occupying space rather than space occupied by the object
 - Geometry is a trait, rather than the defining feature

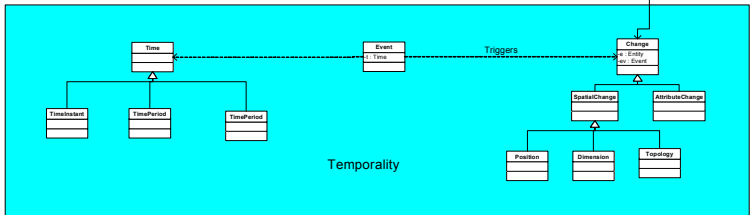
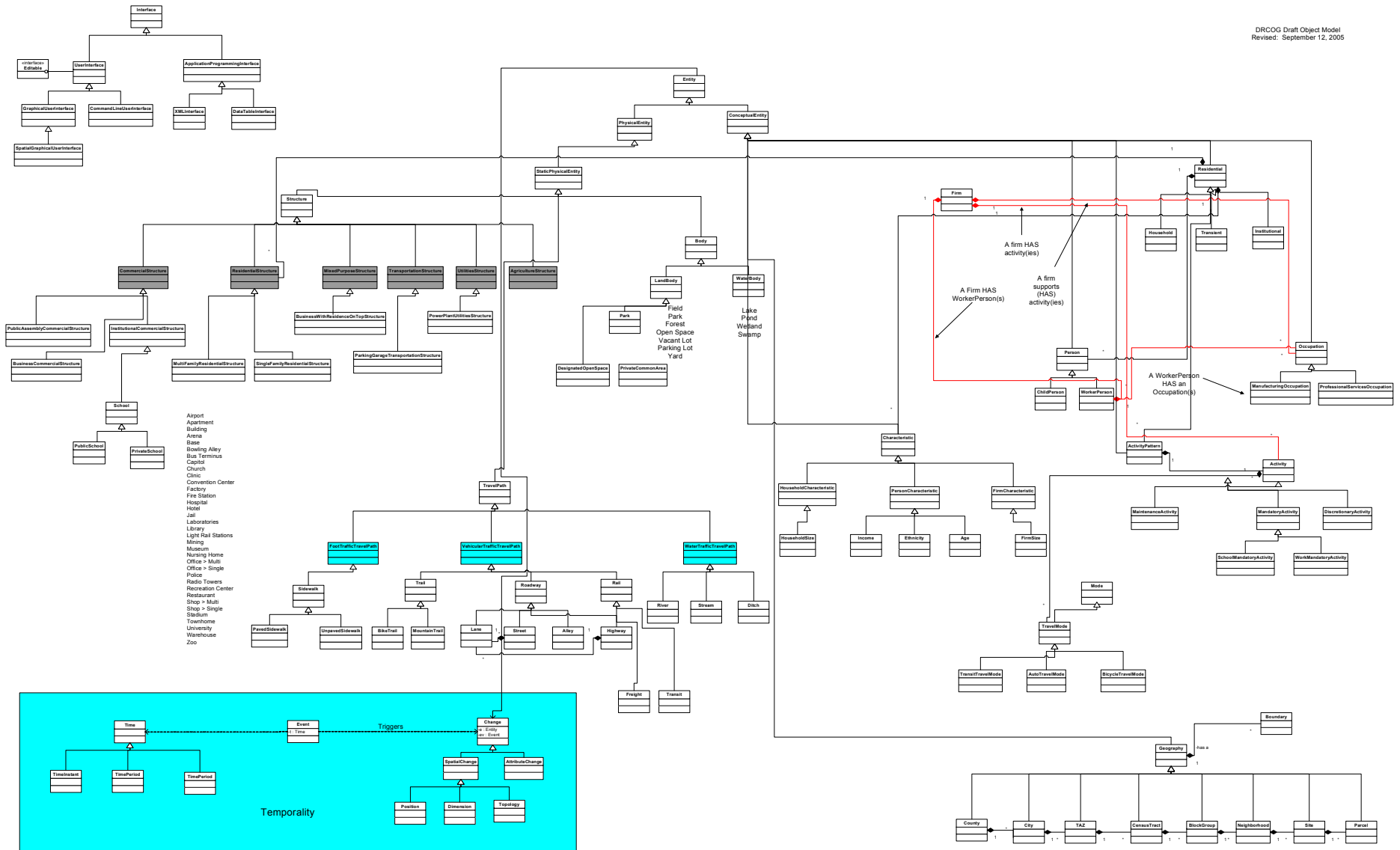

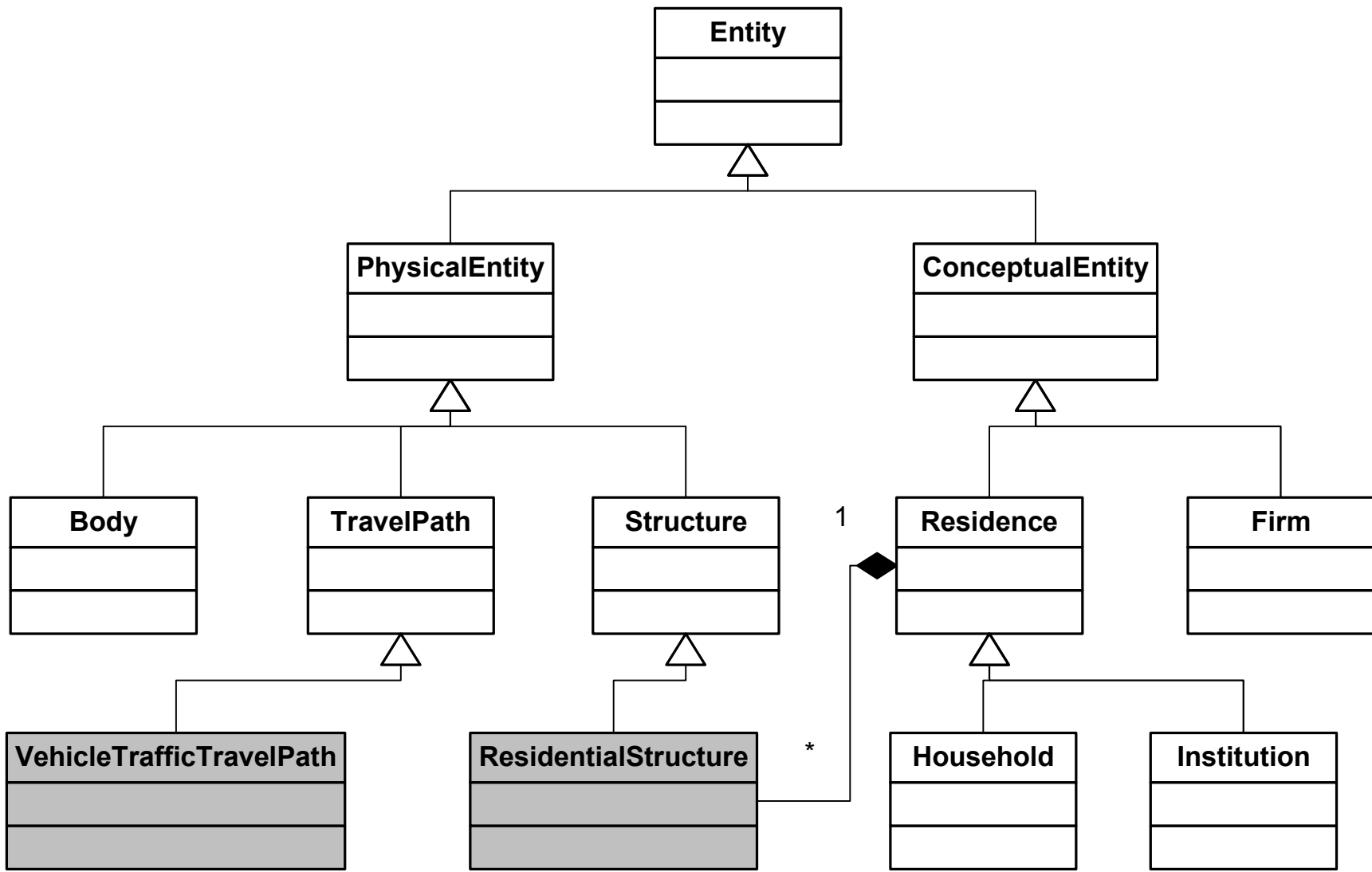

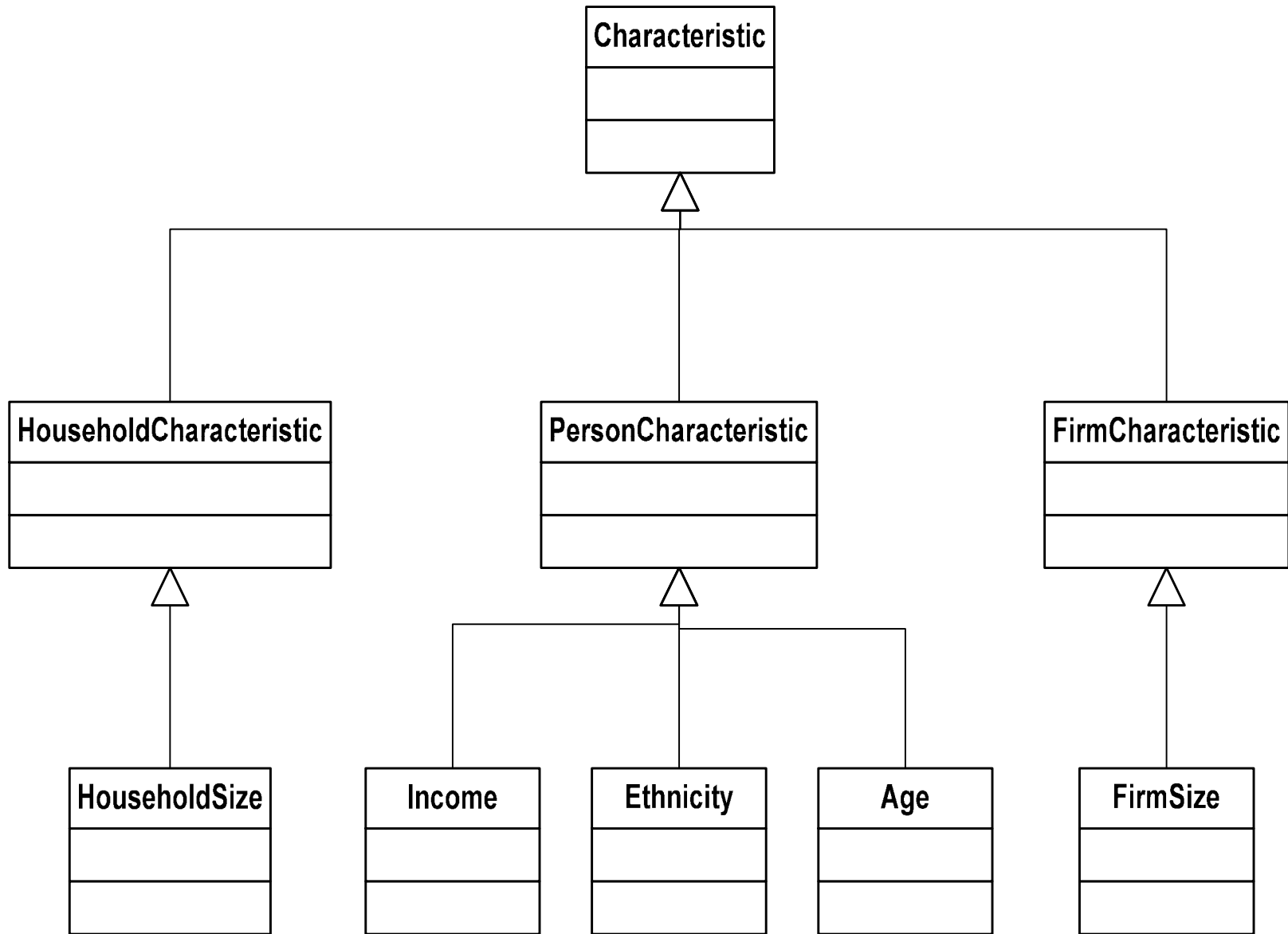

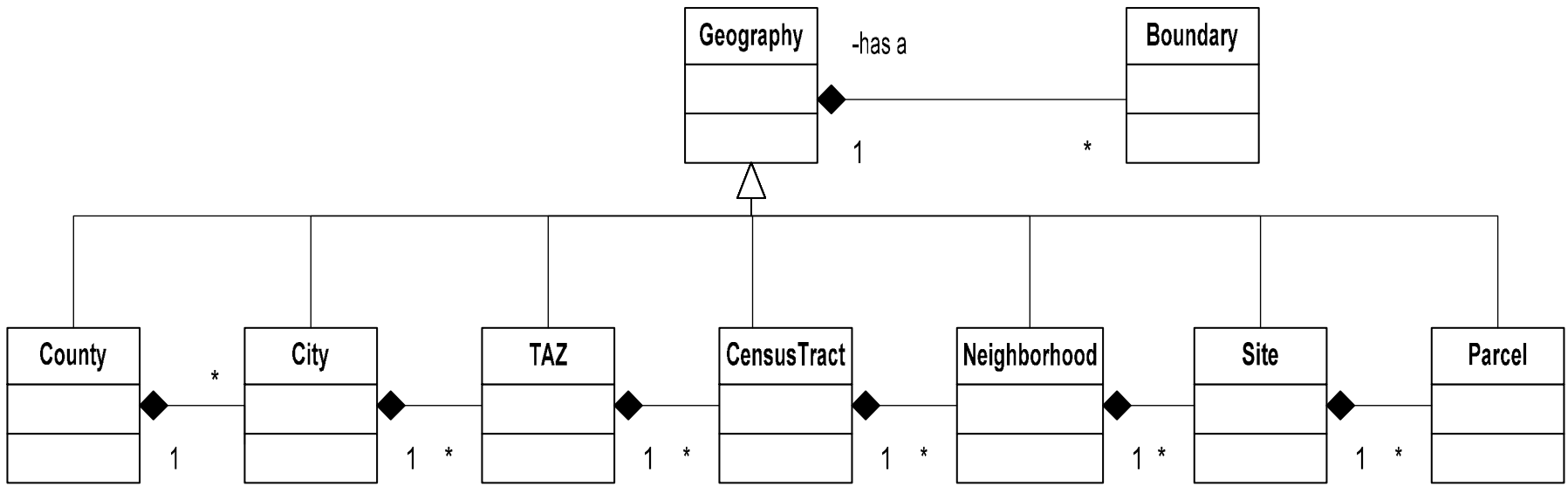

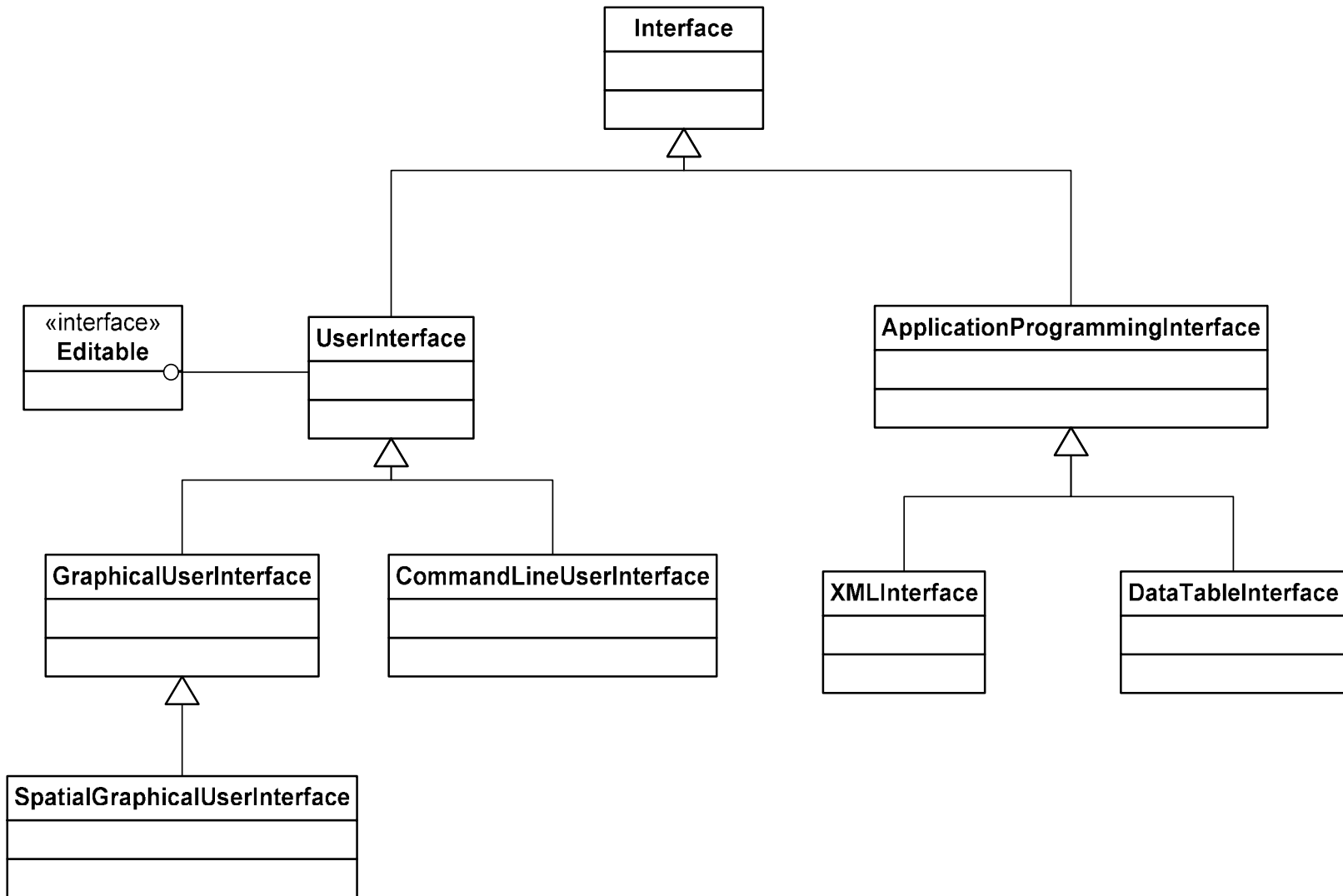

From conceptual to real

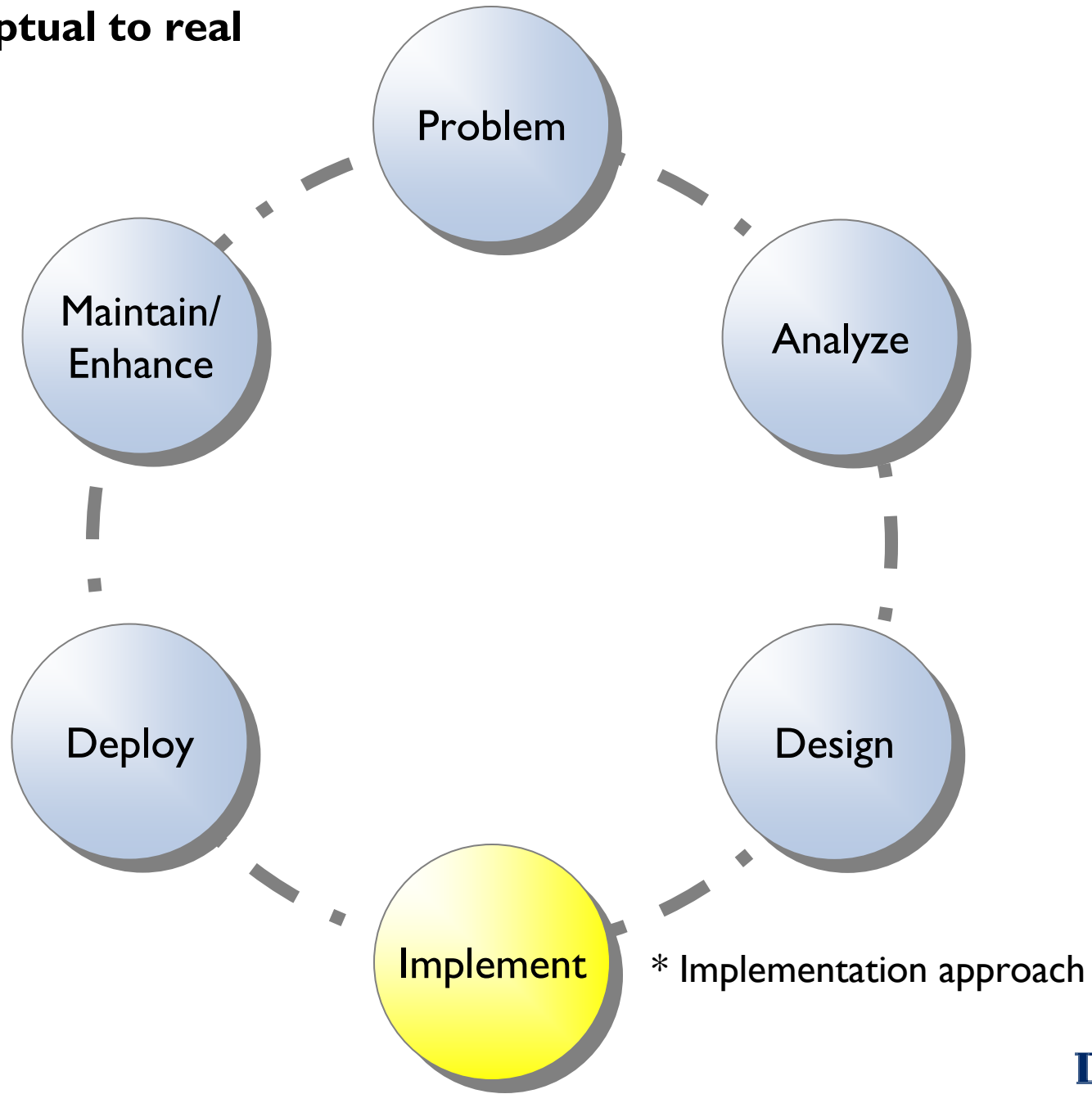

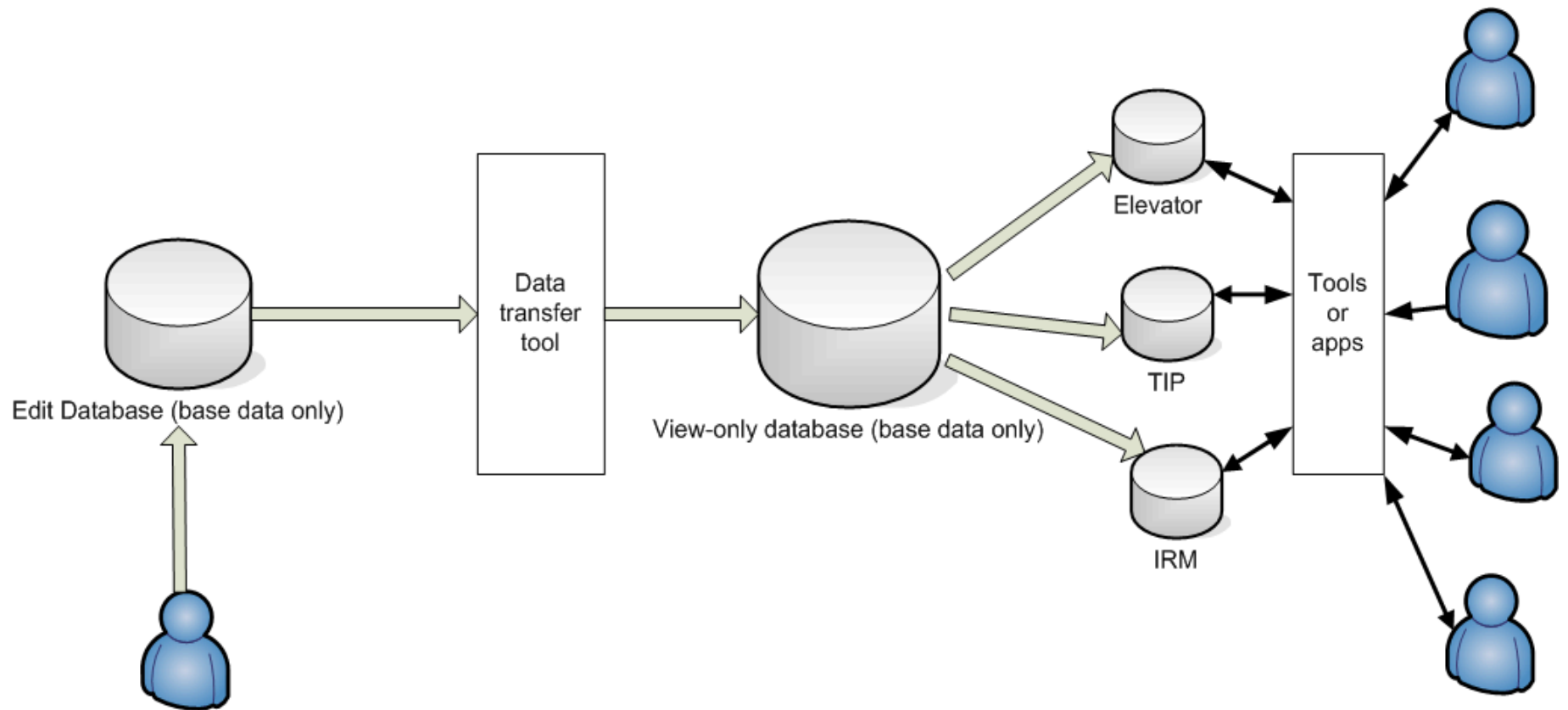

OLAP-OLTP

From conceptual to real

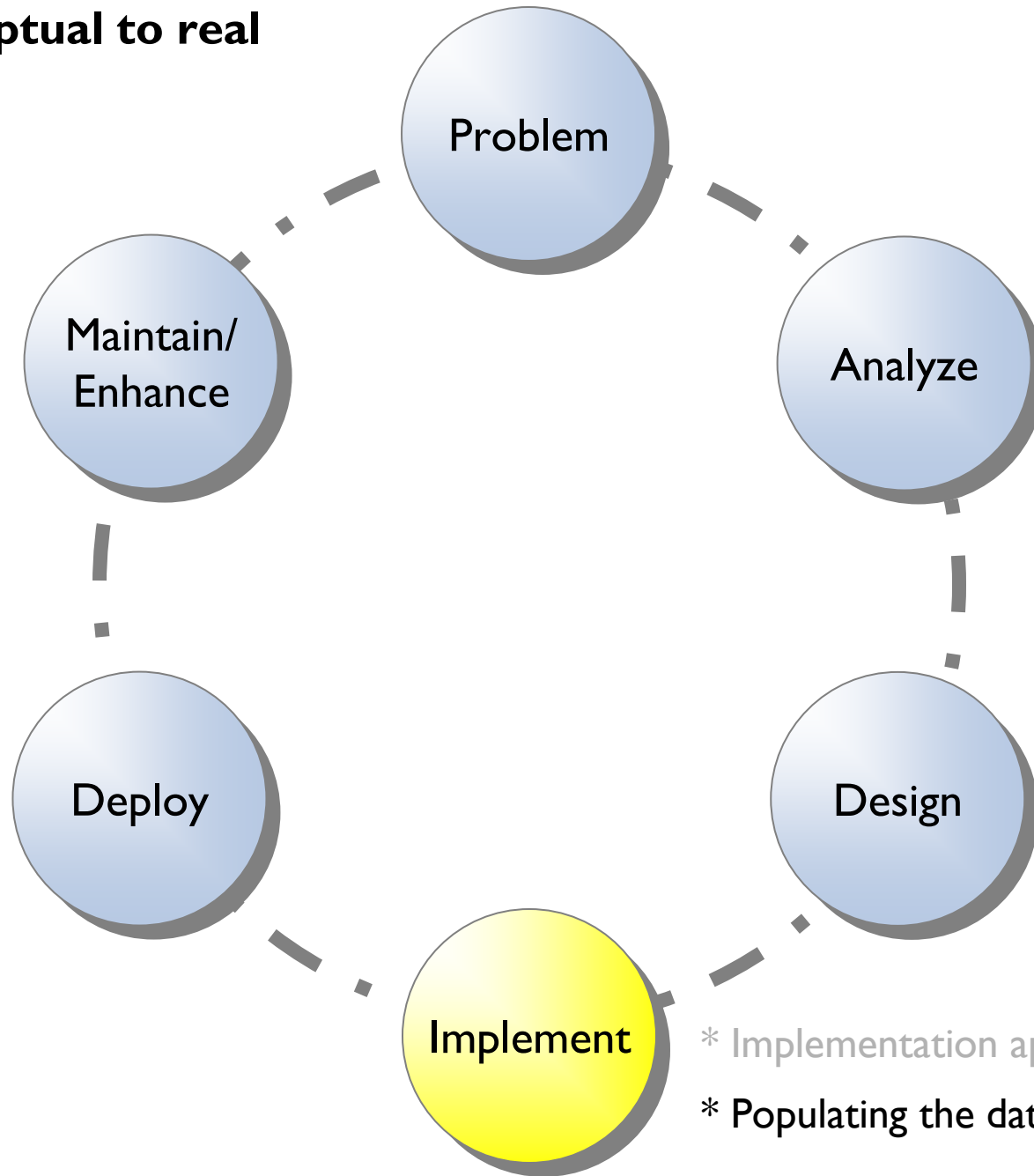

* Implementation approach

* Populating the database

Data work

- Life stage model
 - Inductive analysis
- Base year creation
 - Synthetic pop generation
 - Spatial disaggregation process
- Future year forecasting
 - Life stage transition modeling
 - Figure out later!

Denver Life stage model

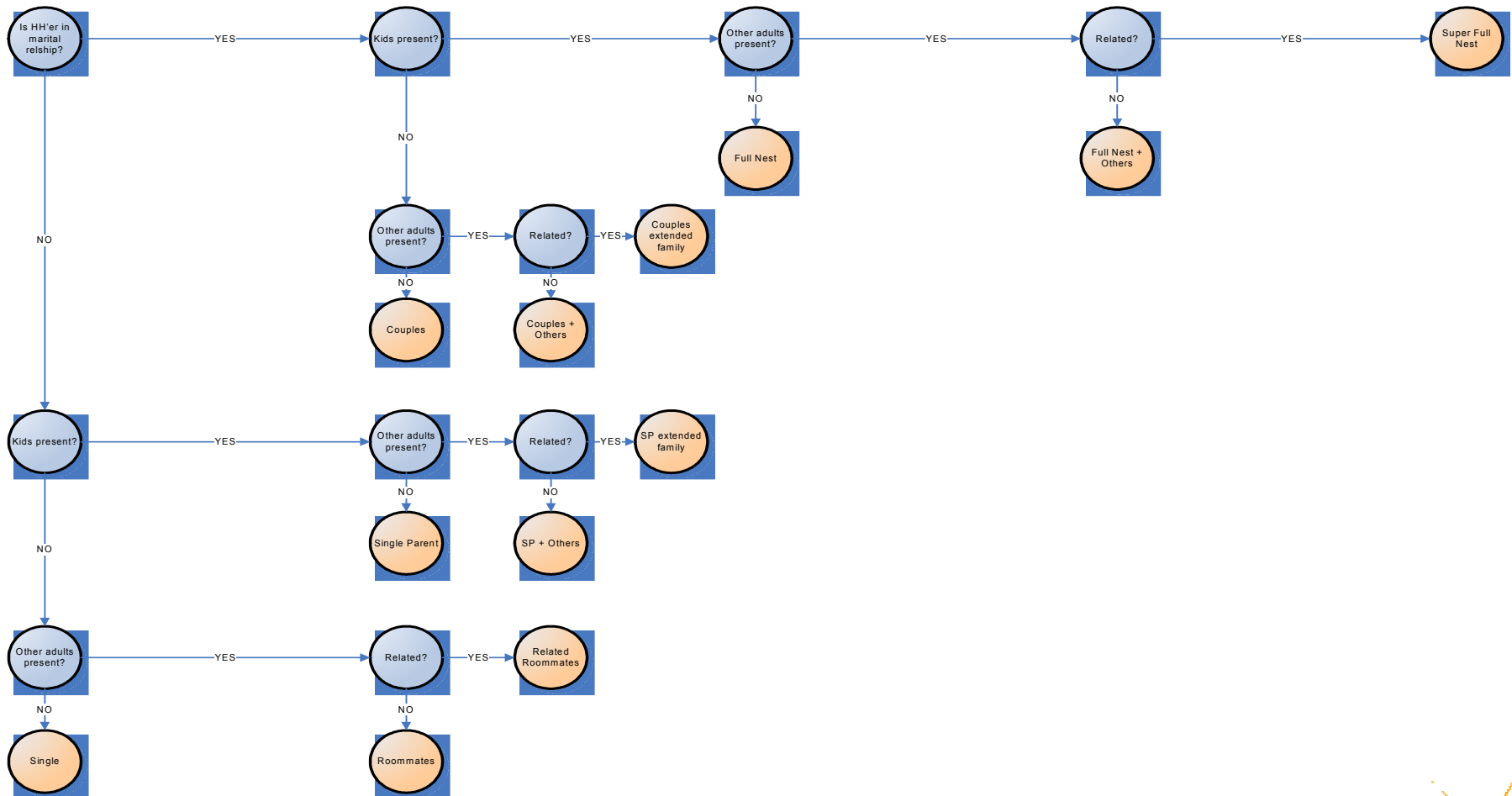

Where next?

A living system

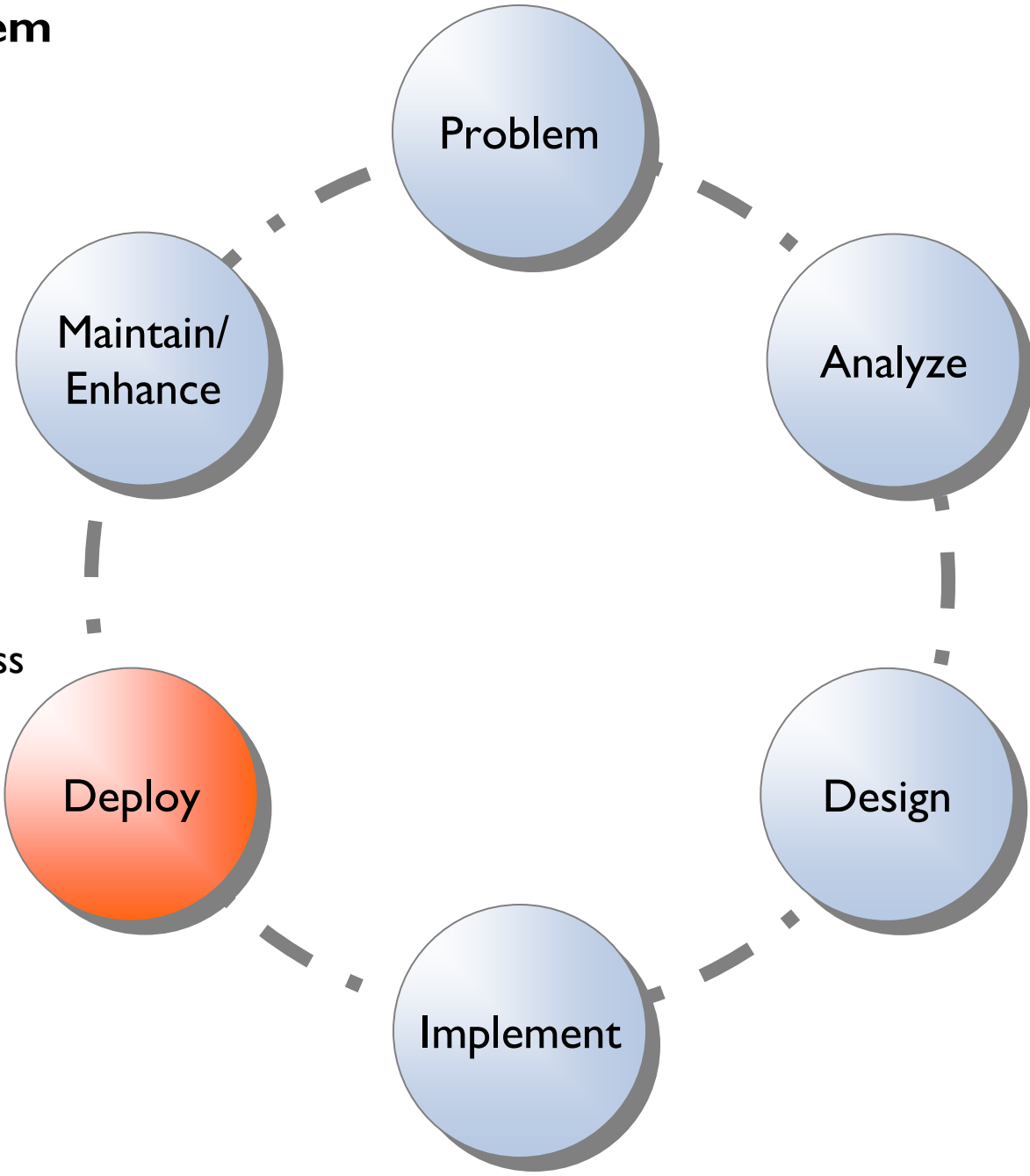

- * Business process change
- * Training
- * Outreach

The next problem?

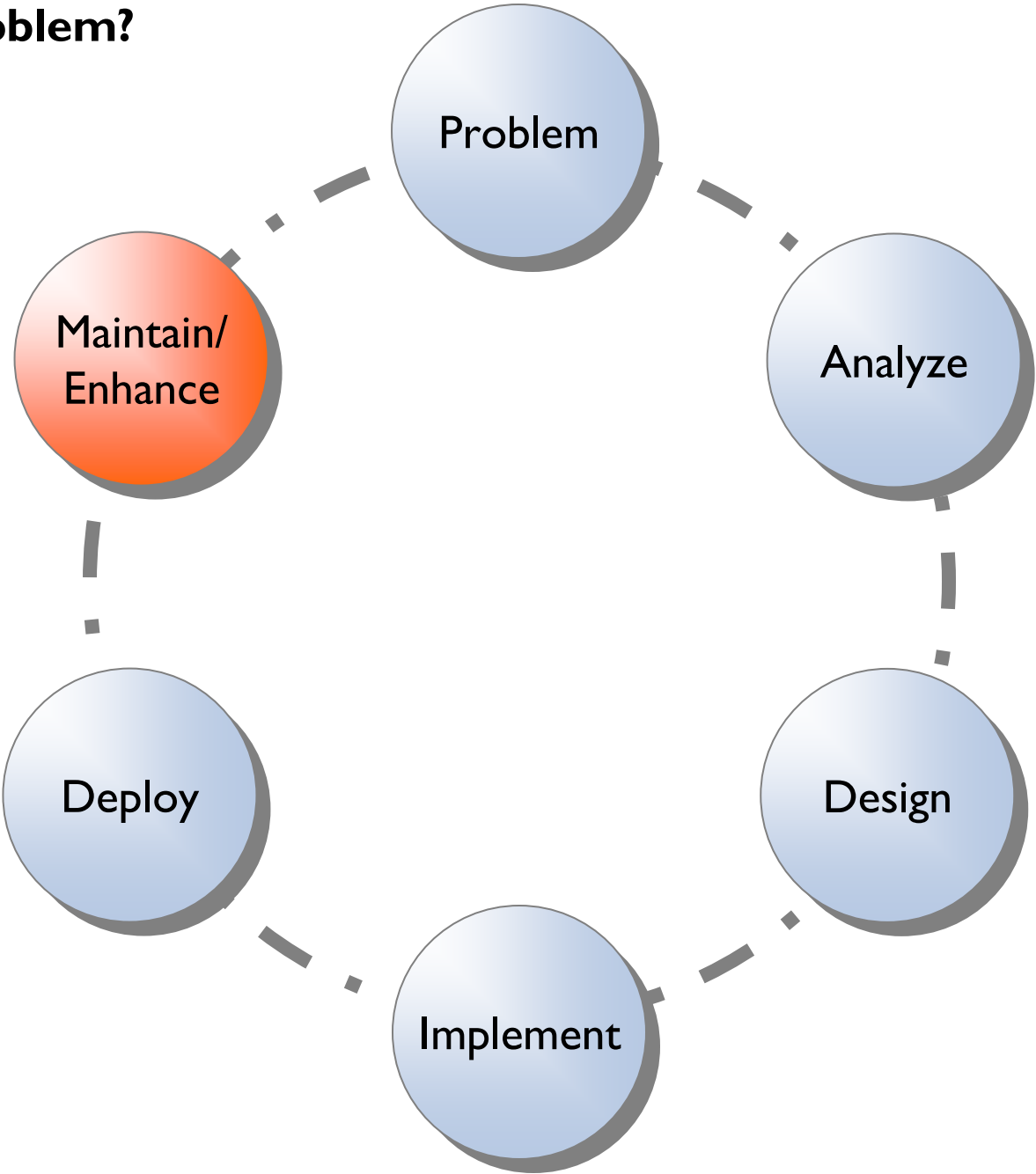

Credits/Contacts

- Simon Montagu
smontagu@drcog.org
- DeVon Culbertson
dculbertson@drcog.org
- Reggie Gonzalez
rgonzalez@drcog.org
- Jeremy Papuga
jpapuga@drcog.org
- Josh Pendleton
jpendleton@drcog.org
- Jill Locantore
jlocantore@drcog.org
- Fernando De Paolis
fdepaolis@drcog.org
- Matt Barry
mbarry@piton.org



